

Filing # 110604715 E-Filed 07/22/2020 10:27:31 AM

**IN THE CIRCUIT COURT OF THE FIFTEENTH JUDICIAL DISTRICT
IN AND FOR PALM BEACH COUNTY, FLORIDA**

ADRIANA VALDOVINOS-CAMPA, an individual:	:	
and DANIELLA CAMPA, an individual,	:	
	:	
Plaintiffs,	:	
	:	
v.	:	Case No.
	:	
SUNBEAM PRODUCTS, INC.,	:	
a foreign for-profit corporation authorized to do	:	
business and doing business within the	:	
State of Florida,	:	
	:	
Defendant.	:	

COMPLAINT

Plaintiffs, by and through their attorneys, **JOHNSON BECKER, PLLC**, upon information and belief, at all times hereinafter mentioned, alleges as follows:

NATURE OF THE CASE

1. Defendant Sunbeam Products, Inc. (hereinafter generally referred to as "Defendant Sunbeam") designs, manufactures, markets, imports, distributes and sells a wide-range of consumer products, including the subject "Crock-Pot Express Crock Multicooker," which specifically includes the Model Number SCCPPC 600-V1 (referred to hereafter as "Pressure Cooker(s)").

2. Defendant Sunbeam touts that its Pressure Cookers are designed with “safety in mind,”¹ which include supposed “safety measures”² such as “safety sensors”³ that purport to keep the lid from being opened while the unit is under pressure.

3. Despite Defendant Sunbeam’s claims of “safety,” it designed, manufactured, marketed, imported, distributed and sold, both directly and through third-party retailers, a product that suffers from serious and dangerous defects. Said defects cause significant risk of bodily harm and injury to its consumers.

4. Specifically, said defects manifest themselves when, despite Defendant Sunbeam’s statements, the lid of the Pressure Cooker is removable with built-up pressure, heat and steam still inside the unit. When the lid is removed under such circumstances, the pressure trapped within the unit causes the scalding hot contents to be projected from the unit and into the surrounding area, including onto the unsuspecting consumers, their families and other bystanders. The Plaintiffs in this case were able to remove the lid while the Pressure Cooker retained pressure, causing them serious and substantial bodily injuries and damages.

5. Defendant Sunbeam knew or should have known of these defects but has nevertheless put profit ahead of safety by continuing to sell its Pressure Cookers to consumers, failing to warn said consumers of the serious risks posed by the defects, and failing to recall the dangerously defective Pressure Cookers regardless of the risk of significant injuries to Plaintiffs and consumers like them.

6. Defendant Sunbeam ignored and/or concealed its knowledge of these defects in its Pressure Cookers from the Plaintiff in this case, as well as the public in general, in order to

¹ See Sunbeam Products, Inc. Crock-Pot Express Crock Multicooker Owner’s Manual, pg. 10, attached hereto as Exhibit A

² *Id.*

³ *Id.*

continue generating a profit from the sale of said Pressure Cookers, demonstrating a callous, reckless, willful, depraved indifference to the health, safety and welfare of Plaintiff and consumers like her.

7. As a direct and proximate result of Defendant Sunbeam's conduct, the Plaintiffs in this case incurred significant and painful bodily injuries, medical expenses, physical pain, mental anguish, and diminished enjoyment of life.

PLAINTIFFS ADRIANA VALDOVINOS-CAMPA & DANIELLA CAMPA

8. Plaintiff Adriana Valdovinos-Campa is a resident and citizen of the city of Newhall, County of Los Angeles, State of California. Plaintiff Danella Campa is Plaintiff Adriana Valdovinos-Campa's daughter.

9. Plaintiff Daniella Campa is a resident and citizen is a resident and citizen of the city of Newhall, County of Los Angeles, State of California. Plaintiff Adrianna Valdovinos-Campa is Plaintiff Daniella Campa's mother.

10. In or around July 2018, Plaintiff Adriana Valdovinos-Campa purchased a new Pressure Cooker, Model No. SCCPPC 600-V1.

11. On or about July 31, 2018, the Plaintiffs suffered serious and substantial burn injuries as the direct and proximate result of the Pressure Cooker's lid being able to be rotated and opened while the Pressure Cooker was still under pressure, during the normal, directed use of the Pressure Cooker, allowing its scalding hot contents to be forcefully ejected from the Pressure Cooker and onto Plaintiff. The incident occurred as a result of the failure of the Pressure Cooker's supposed "safety measures," which purport to keep the consumer safe while using the Pressure Cooker. In addition, the incident occurred as the result of Defendant Sunbeam's failure to redesign the Pressure Cooker, despite the existence of economical, safer alternative designs.

DEFENDANT SUNBEAM PRODUCTS, INC.

12. Defendant Sunbeam designs, manufacturers, markets, imports, distributes and sells a variety of consumer products⁴ including pressure cookers, toasters, panini makers, and mixers, amongst others.

13. Defendant Sunbeam claims that through its “cutting-edge innovation and intelligent design”⁵ it has been “simplifying the lives of everyday people”⁶ for “over 100 years”.⁷

14. Defendant Sunbeam is a Delaware Corporation with its its principal place of business located at 2381 Executive Center Drive, Boca Raton, Florida 33431.

JURISDICTION AND VENUE

15. This Court has personal jurisdiction over Defendant Sunbeam pursuant to Fla. Stat. § 48.193 in that Defendant Sunbeam operates, conducts, engages in, or carries on a business or business venture within this State, and/or committed a tortious act within this State.

16. Venue in this Court is pursuant to Fla. Stat. § 47.011 in that Defendant Sunbeam resides in Palm Beach County.

17. The amount in controversy exceeds the sum of fifteen thousand (\$25,000.00) dollars, exclusive of interest and costs.

⁴ See generally, <https://www.sunbeam.com/> (last accessed June 30, 2020).

⁵ See, <https://www.newellbrands.com/our-brands/sunbeam> (last accessed June 30, 2020).

⁶ *Id.*

⁷ *Id.*

FACTUAL BACKGROUND

18. Defendant Sunbeam is engaged in the business of designing, manufacturing, warranting, marketing, importing, distributing and selling the Pressure Cookers at issue in this litigation.

19. Defendant Sunbeam aggressively warrants, markets, advertises and sells its Pressure Cookers as “an all-in-one appliance that’s always ready when you are,”⁸ allowing consumers to cook “instant, healthy, home-cooked dish in under an hour.”⁹

20. According to the Owner’s Manual¹⁰ accompanying each individual unit sold, the Pressure Cookers purport to be designed with “safety in mind and has various safety measures.”¹¹

21. For instances, the Defendant Sunbeam claims that it’s pressure cookers include “safety sensors”¹² to keep the lid from being opened while the unit is under pressure; that “[p]ressure will not build if the Lid is not shut correctly and has not sealed”¹³; and that “[o]nce the pressure increases, the Lid cannot be opened.”¹⁴

22. In addition to the “safety measures” listed in the manual, Defendant Sunbeam’s Crock-Pot website claims that consumers can “cook with confidence” because the “airtight locking lid remains locked while pressure is inside the unit.”¹⁵

⁸ See <https://www.crock-pot.com/multi-cookers/express-crock/crock-pot-6-quart-express-crock-multi-cooker/SCCPPC600-V1.html> (last accessed June 30, 2020).

⁹ *Id.*

¹⁰ See Sunbeam Products, Inc. Crock-Pot Express Crock Multicooker Owner’s Manual (“Exhibit A”), pg. 10.

¹¹ *Id.*

¹² *Id.*

¹³ *Id.*

¹⁴ *Id.*

¹⁵ See <https://www.crock-pot.com/multi-cookers/express-crock/crock-pot-6-quart-express-crock-multi-cooker/SCCPPC600-V1.html> (last accessed June 30, 2020).

23. By reason of the forgoing acts or omissions, the above-named Plaintiffs purchased their Pressure Cooker with the reasonable expectation that it was properly designed and manufactured, free from defects of any kind, and that it was safe for its intended, foreseeable use of cooking.

24. Plaintiffs used the Pressure Cooker for its intended purpose of preparing meals for themselves and/or their family and did so in a manner that was reasonable and foreseeable by Defendant Sunbeam.

25. However, the aforementioned Pressure Cooker was defectively designed and manufactured by Defendant Sunbeam in that it failed to properly function as to prevent the lid from being removed with normal force while the unit remained pressurized, despite the appearance that all the pressure had been released, during the ordinary, foreseeable and proper use of cooking food with the product; placing the Plaintiffs, their family, and similar consumers in danger while using the Pressure Cookers.

26. Defendant Sunbeam's Pressure Cookers possess defects that make them unreasonably dangerous for their intended use by consumers because the lid can be rotated and opened while the unit remains pressurized.

27. Further, Defendant Sunbeam's representations about "safety" are not just misleading, they are flatly wrong, and put innocent consumers like Plaintiffs directly in harm's way.

28. Economic, safer alternative designs were available that could have prevented the Pressure Cooker's lid from being rotated and opened while pressurized.

29. Defendant Sunbeam knew or should have known that its Pressure Cookers possessed defects that pose a serious safety risk to Plaintiffs and the public. Nevertheless,

Defendant Sunbeam continues to ignore and/or conceal its knowledge of the Pressure Cookers' defects from the general public and continues to generate a substantial profit from the sale of its Pressure Cookers, demonstrating a callous, reckless, willful, depraved indifference to the health, safety and welfare of Plaintiffs and consumers like them.

30. As a direct and proximate result of Defendant Sunbeam's intentional concealment of such defects, its failure to warn consumers of such defects, its negligent misrepresentations, its failure to remove a product with such defects from the stream of commerce, and its negligent design of such products, Plaintiffs used an unreasonably dangerous Pressure Cooker, which resulted in significant and painful bodily injuries upon Plaintiffs' simple removal of the lid of the Pressure Cooker.

31. Consequently, the Plaintiffs in this case seek damages resulting from the use of Defendant Sunbeam's Pressure Cooker as described above, which has caused the Plaintiff to suffer from serious bodily injuries, medical expenses, physical pain, mental anguish, diminished enjoyment of life, and other damages.

CLAIMS FOR RELIEF

COUNT I STRICT LIABILITY

32. Plaintiffs incorporate by reference each preceding and succeeding paragraph as though set forth fully at length herein.

33. At the time of Plaintiffs' injuries, Defendant Sunbeam's Pressure Cookers were defective and unreasonably dangerous for use by foreseeable consumers, including Plaintiffs.

34. Defendant Sunbeam's Pressure Cookers were in the same or substantially similar condition as when they left the possession of Defendant Sunbeam.

35. Plaintiffs did not misuse or materially alter the Pressure Cooker.

36. The Pressure Cookers did not perform as safely as an ordinary consumer would have expected them to perform when used in a reasonably foreseeable way.

37. Further, a reasonable person would conclude that the possibility and serious of harm outweighs the burden or cost of making the Pressure Cookers safe. Specifically:

- a. The Pressure Cookers designed, manufactured, sold, and supplied by Defendant Sunbeam were defectively designed and placed into the stream of commerce in a defective and unreasonably dangerous condition for consumers;
- b. The seriousness of the potential burn injuries resulting from the product drastically outweighs any benefit that could be derived from its normal, intended use;
- c. Defendant Sunbeam failed to properly market, design, manufacture, distribute, supply, and sell the Pressure Cookers, despite having extensive knowledge that the aforementioned injuries could and did occur;
- d. Defendant Sunbeam failed to warn and place adequate warnings and instructions on the Pressure Cookers;
- e. Defendant Sunbeam failed to adequately test the Pressure Cookers; and
- f. Defendant Sunbeam failed to market an economically feasible alternative design, despite the existence of the aforementioned economical, safer alternatives, that could have prevented the Plaintiff' injuries and damages.

38. Defendant Sunbeam's actions and omissions were the direct and proximate cause of the Plaintiffs' injuries and damages.

39. Defendant Sunbeam's conduct, as described above, was extreme and outrageous. Defendant Sunbeam risked the safety and well-being of the consumers and users of its Pressure Cookers, including the Plaintiffs to this action, with the knowledge of the safety and efficacy problems and suppressed this knowledge from the public. Defendant Sunbeam made conscious decisions not to redesign, warn or inform the unsuspecting consuming public. Defendant Sunbeam's outrageous conduct warrants an award of punitive damages.

WHEREFORE, Plaintiffs demand judgment against Defendant Sunbeam for compensatory and punitive damages, together with interest, costs of suit, attorneys' fees, and all such other relief as the Court deems proper.

COUNT II
NEGLIGENCE

40. Plaintiffs incorporate by reference each preceding and succeeding paragraph as though set forth fully at length herein.

41. Defendant Sunbeam has a duty of reasonable care to design, manufacture, market, and sell non-defective Pressure Cookers that are reasonably safe for their intended uses by consumers, such as Plaintiffs and their family.

42. Defendant Sunbeam failed to exercise ordinary care in the manufacture, sale, warnings, quality assurance, quality control, distribution, advertising, promotion, sale and marketing of its Pressure Cookers in that Defendant Sunbeam knew or should have known that said Pressure Cookers created a high risk of unreasonable harm to the Plaintiffs and consumers alike.

43. Defendant Sunbeam was negligent in the design, manufacture, advertising, warning, marketing and sale of its Pressure Cookers in that, among other things, it:

- a. Failed to use due care in designing and manufacturing the Pressure Cookers to avoid the aforementioned risks to individuals;
- b. Placed an unsafe product into the stream of commerce;
- c. Aggressively over-promoted and marketed its Pressure Cookers through television, social media, and other advertising outlets; and
- d. Were otherwise careless or negligent.

44. Despite the fact that Defendant Sunbeam knew or should have known that consumers were able to remove the lid while the Pressure Cookers were still pressurized,

Defendant Sunbeam continued to market (and continues to do so) its Pressure Cookers to the general public.

45. Defendant Sunbeam's conduct, as described above, was extreme and outrageous. Defendant Sunbeam risked the safety and well-being of the consumers and users of its Pressure Cookers, including the Plaintiff to this action, with the knowledge of the safety and efficacy problems and suppressed this knowledge from the public. Defendant Sunbeam made conscious decisions not to redesign, warn or inform the unsuspecting consuming public. Defendant Sunbeam's outrageous conduct warrants an award of punitive damages.

WHEREFORE, Plaintiffs demand judgment against Defendant Sunbeam for compensatory and punitive damages, together with interest, costs of suit, attorneys' fees, and all such other relief as the Court deems proper.

COUNT III
DESIGN DEFECT

46. Plaintiffs incorporate by reference each preceding and succeeding paragraph as though set forth fully at length herein.

47. Defendant Sunbeam is the manufacturer, seller, distributor, marketer, and supplier of the subject Pressure Cookers, which were negligently designed.

48. Defendant Sunbeam failed to exercise reasonable care in designing, developing, manufacturing, inspecting, testing, packaging, selling, distributing, labeling, marketing, and promoting its Pressure Cookers, which were defective and presented an unreasonable risk of harm to consumers, such as the Plaintiffs.

49. As a result, the subject Pressure Cookers, including Plaintiffs' Pressure Cooker, contain defects in their design which render them unreasonably dangerous to consumers, such as the Plaintiffs, when used as intended or as reasonably foreseeable to Defendant Sunbeam. The

defect in the design allows consumers such as Plaintiffs to open the lid while the unit remains pressurized, despite the appearance that all the pressure has been released from the unit, and causes an unreasonable increased risk of injury, including, but not limited to, first, second and third-degree scald burns.

50. The Plaintiffs in this case used their Pressure Cooker in a reasonably foreseeable manner and did so as substantially intended by Defendant Sunbeam.

51. The subject Pressure Cooker was not materially altered or modified after being manufactured by Defendant Sunbeam and before being used by Plaintiffs.

52. The design defects allowing the lid to open while the unit was still pressurized directly rendered the Pressure Cookers defective and were the direct and proximate result of Defendant Sunbeam's negligence and failure to use reasonable care in designing, testing, manufacturing, and promoting the Pressure Cookers.

53. As a direct and proximate result of Defendant Sunbeam's negligent design of its Pressure Cookers, the Plaintiffs in this case suffered injuries and damages described herein.

54. Despite the fact that Defendant Sunbeam knew or should have known that the Plaintiffs and consumers like them were able to remove the lid while the Pressure Cookers were still pressurized, Defendant Sunbeam continued to market its Pressure Cookers to the general public (and continues to do so).

55. Defendant Sunbeam's conduct, as described above, was extreme and outrageous. Defendant Sunbeam risked the safety and well-being of the consumers and users of its Pressure Cookers, including the Plaintiffs to this action, with the knowledge of the safety and efficacy problems and suppressed this knowledge from the public. Defendant Sunbeam made conscious decisions not to redesign, despite the existence of economically feasible, safer alternative

designs, warn or inform the unsuspecting consuming public. Defendant Sunbeam's outrageous conduct warrants an award of punitive damages.

WHEREFORE, Plaintiffs demand judgment against Defendant Sunbeam for compensatory and punitive damages, together with interest, costs of suit, attorneys' fees, and all such other relief as the Court deems proper.

COUNT IV
FAILURE TO WARN

56. Plaintiffs incorporate by reference each preceding and succeeding paragraph as though set forth fully herein.

57. At the time in which the Pressure Cooker was purchased, up through the time Plaintiffs were injured, Defendant Sunbeam knew or had reason to know that its Pressure Cookers were dangerous and created an unreasonable risk of harm to consumers.

58. Defendant Sunbeam had a duty to exercise reasonable care to warn consumers of the dangerous conditions or the facts that made its Pressure Cookers likely to be dangerous.

59. As a direct and proximate result of Defendant Sunbeam's failure to warn of the dangers of its Pressure Cookers, the Plaintiffs in this case suffered injuries and damages described herein.

60. Despite the fact that Defendant Sunbeam knew or should have known that consumers were able to remove the lid while the Pressure Cookers were still pressurized, Defendant Sunbeam continued to market its Pressure Cookers to the general public (and continues to do so).

61. Defendant Sunbeam's conduct, as described above, was extreme and outrageous. Defendant Sunbeam risked the safety and well-being of the consumers and users of its Pressure

Cookers, including the Plaintiff to this action, with the knowledge of the safety and efficacy problems and suppressed this knowledge from the public. Defendant Sunbeam made conscious decisions not to redesign, warn or inform the unsuspecting consuming public. Defendant Sunbeam's outrageous conduct warrants an award of punitive damages.

WHEREFORE, Plaintiffs demand judgment against Defendant Sunbeam for compensatory and punitive damages, together with interest, costs of suit, attorneys' fees, and all such other relief as the Court deems proper.

COUNT V
BREACH OF EXPRESS WARRANTY

62. Plaintiffs incorporate by reference each preceding and succeeding paragraph as though set forth fully at length herein.

63. Defendant Sunbeam expressly warranted that its Pressure Cookers were safe and effective to members of the consuming public, including Plaintiffs. Moreover, Defendant Sunbeam expressly warranted that the lid of the Pressure Cooker could not be removed while the unit remained pressurized. Specifically:

- a. "Pressure will not build if the Lid is not shut correctly and has not sealed."¹⁶
- b. Once the pressure increases, the Lid cannot be opened. Safety sensors ensure the pressure remains within the set range."¹⁷
- c. "Airtight locking lid remains locked while pressure is inside the unit."¹⁸

64. Members of the consuming public, including consumers such as the Plaintiff were the intended third-party beneficiaries of the warranty.

¹⁶ See Sunbeam Products, Inc. Crock-Pot Express Crock Multicooker Owner's Manual ("Exhibit A"), pg. 10.

¹⁷ *Id.*

¹⁸ See <https://www.crock-pot.com/multi-cookers/express-crock/crock-pot-6-quart-express-crock-multi-cooker/SCCPPC600-V1.html> (last accessed June 30, 2020).

65. Defendant Sunbeam marketed, promoted and sold its Pressure Cookers as a safe product, complete with “safety measures.”

66. Defendant Sunbeam’s Pressure Cookers do not conform to these express representations because the lid can be removed using normal force while the units remain pressurized, despite the appearance that the pressure has been released, making the Pressure Cookers not safe for use by consumers.

67. Defendant Sunbeam breached its express warranty in one or more of the following ways:

- a. The Pressure Cookers as designed, manufactured, sold and/or supplied by the Defendant Sunbeam, were defectively designed and placed into the stream of commerce by Defendant Sunbeam in a defective and unreasonably dangerous condition;
- b. Defendant Sunbeam failed to warn and/or place adequate warnings and instructions on its Pressure Cookers;
- c. Defendant Sunbeam failed to adequately test its Pressure Cookers; and,
- d. Defendant Sunbeam failed to provide timely and adequate post-marketing warnings and instructions after they knew the risk of injury from its Pressure Cookers.

68. The Plaintiffs in this case and/or her family purchased and used the Pressure Cooker with the reasonable expectation that it was properly designed and manufactured, free from defects of any kind, and that it was safe for its intended, foreseeable use of cooking.

69. Plaintiffs’ injuries were the direct and proximate result of Defendant Sunbeam’s breach of its express warranties.

70. Defendant Sunbeam’s conduct, as described above, was extreme and outrageous. Defendant Sunbeam risked the safety and well-being of the consumers and users of its Pressure Cookers, including the Plaintiff to this action, with the knowledge of the safety and efficacy problems and suppressed this knowledge from the public. Defendant Sunbeam made conscious

decisions not to redesign, warn or inform the unsuspecting consuming public. Defendant Sunbeam's outrageous conduct warrants an award of punitive damages.

WHEREFORE, Plaintiffs demand judgment against Defendant Sunbeam for compensatory and punitive damages, together with interest, costs of suit, attorneys' fees, and all such other relief as the Court deems proper.

COUNT VI
BREACH OF IMPLIED WARRANTY OF FITNESS
FOR A PARTICULAR PURPOSE

71. Plaintiff incorporates by reference each preceding and succeeding paragraph as though set forth fully at length herein.

72. Defendant Sunbeam manufactured, supplied, and sold its Pressure Cookers with an implied warranty that they were fit for the particular purpose of cooking quickly, efficiently and safely.

73. Members of the consuming public, including consumers such as the Plaintiffs, were the intended third-party beneficiaries of the warranty.

74. Defendant Sunbeam's Pressure Cookers were not fit for the particular purpose as a safe means of cooking, due to the unreasonable risks of bodily injury associated with their use.

75. The Plaintiffs in this case reasonably relied on Defendant Sunbeam's representations that its Pressure Cookers were a quick, effective and safe means of cooking.

76. Defendant Sunbeam's breach of the implied warranty of fitness for a particular purpose was the direct and proximate cause of Plaintiffs' injuries and damages.

77. Defendant Sunbeam's conduct, as described above, was extreme and outrageous. Defendant Sunbeam risked the safety and well-being of the consumers and users of its Pressure Cookers, including the Plaintiffs to this action, with the knowledge of the safety and efficacy

problems and suppressed this knowledge from the public. Defendant Sunbeam made conscious decisions not to redesign, warn or inform the unsuspecting consuming public. Defendant Sunbeam's outrageous conduct warrants an award of punitive damages.

WHEREFORE, Plaintiffs demand judgment against Defendant Sunbeam for compensatory and punitive damages, together with interest, costs of suit, attorneys' fees, and all such other relief as the Court deems proper.

COUNT VII
BREACH OF IMPLIED WARRANTY OF MERCHANTABILITY

78. Plaintiff incorporates by reference each preceding and succeeding paragraph as though set forth fully at length herein.

79. At the time Defendant Sunbeam marketed, distributed and sold its Pressure Cookers to the Plaintiff in this case, Defendant Sunbeam warranted that its Pressure Cookers were merchantable and fit for the ordinary purposes for which they were intended.

80. Members of the consuming public, including consumers such as the Plaintiffs, were intended third-party beneficiaries of the warranty.

81. Defendant Sunbeam's Pressure Cookers were not merchantable and fit for their ordinary purpose, because they had the propensity to lead to the serious personal injuries as described herein in this Complaint.

82. The Plaintiffs in this case purchased and used the Pressure Cooker with the reasonable expectation that it was properly designed and manufactured, free from defects of any kind, and that it was safe for its intended, foreseeable use of cooking.

83. Defendant Sunbeam's breach of implied warranty of merchantability was the direct and proximate cause of Plaintiffs' injuries and damages.

84. Defendant Sunbeam's conduct, as described above, was extreme and outrageous. Defendant Sunbeam risked the safety and well-being of the consumers and users of its Pressure Cookers, including the Plaintiff to this action, with the knowledge of the safety and efficacy problems and suppressed this knowledge from the public. Defendant Sunbeam made conscious decisions not to redesign, warn or inform the unsuspecting consuming public. Defendant Sunbeam's outrageous conduct warrants an award of punitive damages.

WHEREFORE, Plaintiffs demand judgment against Defendant Sunbeam for compensatory and punitive damages, together with interest, costs of suit, attorneys' fees, and all such other relief as the Court deems proper.

COUNT VII
VIOLATION OF FLORIDA DECEPTIVE AND UNFAIR TRADE PRACTICES ACT
FLA. STAT. § 501.201, et. seq.

85. Plaintiffs incorporate by reference each preceding and succeeding paragraph as though set forth fully at length herein.

86. Pursuant to the Florida Deceptive and Unfair Trade Practices Act ("FDUTPA") any "unfair methods of competition, unconscionable acts or practices, and unfair or deceptive acts or practices in the conduct of any trade or commerce" are unlawful. Fla. Stat. § 501.204(1).

87. At all times material herein, Defendant Sunbeam engaged in "trade or commerce," as defined by § 501.203(8) FDUTPA by "advertising, soliciting, providing, offering, or distributing" its dangerous and defective Pressure Cookers. Fla. Stat. § 501.203(8).

88. Defendant Sunbeam warranted and represented that its Pressure Cookers were safe and free of defects in materials and workmanship and that they possessed "safety measures", including "safety sensors" and an "Airtight locking lid."

89. Defendant Sunbeam's warranty and representations that its Pressure Cookers were safe and free from defects, including that they possessed "safety measures," would influence a reasonable consumer's decision whether to purchase the Pressure Cookers.

90. Defendant Sunbeam's failure to warn of its Pressure Cookers defects was a material omission that would influence a reasonable consumer's decision whether to purchase its Pressure Cookers.

91. The Plaintiffs are "interested parties or persons" as defined by § 501.203 (6) of the FDUTPA. Fla. Stat. § 501.203 (6).

92. Plaintiffs relied on the truth of Defendant Sunbeam's warranties and representations concerning the Pressure Cookers, and Plaintiffs suffered personal damages as result of this reliance.

93. Had Plaintiffs been adequately warned concerning the likelihood that the Pressure Cooker's lid could be removed while pressurized, they would have taken steps to avoid damages by not purchasing this product. As a result of these violations of consumer protection laws, the Plaintiffs in this case have incurred and will incur: serious physical injury, pain, suffering, loss of income, loss of opportunity, loss of family and social relationships, and medical and hospital expenses and other expense related to the diagnosis and treatment thereof, for which Defendant Sunbeam is liable.

WHEREFORE, Plaintiffs demand judgment against Defendant Sunbeam for compensatory and punitive damages, together with interest, costs of suit, attorneys' fees, and all such other relief as the Court deems proper.

COUNT VIII
PUNITIVE DAMAGES

94. Plaintiffs incorporate by reference each of the allegations set forth in this Complaint as though fully set forth herein.

95. The acts, conduct, and omissions of Defendant Sunbeam, as alleged throughout this Complaint, were willful and malicious. It is unconscionable and outrageous that Defendant Sunbeam would risk the health, safety, and well-being of consumers, including the Plaintiffs in this case. Despite its knowledge that the lid could be prematurely removed while the unit remained pressurized, Defendant Sunbeam made conscious decisions not to redesign, despite the existence of an economically feasible, safer alternative design, and not to adequately label, warn or inform the unsuspecting consuming public about the dangers associated with the use of its Pressure Cookers. Defendant Sunbeam's outrageous conduct rises to the level that Plaintiffs should be awarded punitive damages to deter Defendant Sunbeam from this type of outrageous conduct in the future, as well as to discourage other Defendants from placing profits above the safety of consumers in the United States of America.

96. Prior to and during the manufacturing, sale, and distribution of its Pressure Cookers, Defendant Sunbeam knew that said Pressure Cookers were in a defective condition as previously described herein and knew that those who purchased and used its Pressure Cookers, including Plaintiff, could experience severe physical, mental, and emotional injuries.

97. Further, Defendant Sunbeam knew that its Pressure Cookers presented a substantial and unreasonable risk of harm to the public, including Plaintiffs, and as such, Defendant Sunbeam unreasonably subjected consumers of said Pressure Cookers to risk of serious and permanent injury from their use.

98. Despite its knowledge, Defendant Sunbeam, for the purpose of enhancing its profits, knowingly and deliberately failed to remedy the known defects in its Pressure Cookers, and failed to warn the public, including Plaintiffs, of the extreme risk of injury occasioned by said defects inherent in them. Defendant Sunbeam intentionally proceeded with the manufacturing, sale, distribution and marketing of its Pressure Cookers knowing these actions would expose consumers, such as the Plaintiffs, to serious danger in order to advance its pecuniary interest and monetary profits.

99. Defendant Sunbeam's conduct was despicable and so contemptible that it would be looked down upon and despised by ordinary decent people and was carried on by Defendant Sunbeam with willful and conscious disregard for the safety of the Plaintiffs and consumers like them, entitling the Plaintiffs to punitive damages.

WHEREFORE, Plaintiffs demand judgment against Defendant Sunbeam for compensatory and punitive damages, together with interest, costs of suit, attorneys' fees, and all such other relief as the Court deems proper.

DEMAND FOR JURY TRIAL

Plaintiffs demand that all issues of fact of this case be tried to a properly impaneled jury to the extent permitted under the law.

PRAYER FOR RELIEF

WHEREFORE, Plaintiffs demand judgment against the Defendant Sunbeam for damages, including punitive damages, to which they entitled by law, as well as all costs of this action, interest and attorneys' fees, to the full extent of the law, whether arising under the common law and/or statutory law, including:

- a. judgment for Plaintiffs and against Defendant Sunbeam;

- b. damages to compensate Plaintiffs for their injuries, economic losses and pain and suffering sustained as a result of the use of the Defendant Sunbeam's Pressure Cookers;
- c. pre and post judgment interest at the lawful rate;
- d. exemplary and punitive damages on all applicable Counts as permitted by the law;
- e. a trial by jury on all issues of the case;
- f. an award of attorneys' fees; and
- g. for any other relief as this Court may deem equitable and just, or that may be available under the law of another forum to the extent the law of another forum is applied, including but not limited to all reliefs prayed for in this Complaint and in the foregoing Prayer for Relief.

Respectfully submitted,

JOHNSON BECKER, PLLC

Date: July 22, 2020

/s/ Lisa A. Gorshe, Esq.

Lisa A. Gorshe, Esq. (FL #122180)

Michael K. Johnson, Esq. (MN ID #0258696)

Pro Hac Vice to be filed

Kenneth W. Pearson, Esq. (MN ID #016088X)

Pro Hac Vice to be filed

Adam J. Kress, Esq. (MN #0397289)

Pro Hac Vice to be filed

444 Cedar Street, Suite 1800

(612) 436-1800 / (612) 436-1801 (fax)

lgorsche@johnsonbecker.com

mjohnson@johnsonbecker.com

kpearson@johnsonbecker.com

akress@johnsonbecker.com

Attorneys for Plaintiff

Filing # 110604715 E-Filed 07/22/2020 10:27:31 AM

EXHIBIT A
Crock-Pot Express Crock Multicooker,
Model Number SCCPPC 600-V1
Owner's Manual

SERVICE INSTRUCTIONS

1. This Multi-Cooker has no user serviceable parts. Do NOT attempt to repair or adjust any electrical or mechanical functions on this Multi-Cooker. Doing so may cause injuries and void the warranty. Any servicing beyond that described in the CARE AND CLEANING section should be performed by an Authorized Service Representative only. See Warranty Section.
2. If you need to exchange the Multi-Cooker, please return it in its original carton, with a sales receipt, to the store where you purchased it. If you are returning the Multi-Cooker more than 30 days after the date of purchase, please see the enclosed Warranty.
3. If you have any questions or comments regarding this Multi-Cooker's operation or believe any repair is necessary, please call our Consumer Service Department at 1-800-323-9519 or visit our website at www.crockpot.com.

1 YEAR LIMITED WARRANTY

Sunbeam Products, Inc. doing business as Jarlen Consumer Solutions or in Canada, Sunbeam Corporation (Canada) Limited, doing business as Jarlen Consumer Solutions (collectively "JCS") warrants that for a period of one year from the date of purchase, this product will be free from defects in material and workmanship. JCS, at its option, will repair or replace this product or any component of the product found to be defective during the warranty period. Replacement will be made with a new or remanufactured product or component. If the product is no longer available, replacement may be made with a similar product of equal or greater value. This is your exclusive warranty. Do NOT attempt to repair or adjust any electrical or mechanical functions on this product. Doing so will void this warranty. This warranty is valid for the original retail purchaser from the date of initial retail purchase and is not transferable. Keep the original sales receipt. Proof of purchase is required to obtain warranty performance. JCS dealers, service centers, or retail stores selling JCS products do not have the right to alter, modify or any way change the terms and conditions of this warranty. This warranty does not cover normal wear of parts or damage resulting from any of the following: negligent use or misuse of the product; use on improper voltage or current; use contrary to the operating instructions; disassembly, repair or alteration by anyone other than JCS or an authorized JCS service center. Further, the warranty does not cover: Acts of God, such as fire, flood, hurricanes and tornadoes.

What are the limits on JCS's Liability?

JCS shall not be liable for any incidental or consequential damages caused by the breach of any express, implied or statutory warranty or condition. Except to the extent prohibited by applicable law, any implied warranty or condition of merchantability or fitness for a particular purpose is limited in duration to the duration of the above warranty. JCS disclaims all other warranties, conditions or representations, express, implied, statutory or otherwise. JCS shall not be liable for any damages of any kind resulting from the purchase, use or misuse of, or inability to use the product including incidental, special, consequential or similar damages or loss of profits, or for any breach of contract, fundamental or otherwise, or for any claim brought against purchaser by any other party. Some provinces, states or jurisdictions do not allow the exclusion or limitation of incidental or consequential damages or limitations on how long an implied warranty lasts, so the above limitations or exclusion may not apply to you. This warranty gives you specific legal rights, and you may also have other rights that vary from province to province, state to state or jurisdiction to jurisdiction.

How to Obtain Warranty Service

In the U.S.A.

If you have any questions regarding this warranty or would like to obtain warranty service, please call 1-800-323-9519 and a convenient service center address will be provided to you.

In Canada

If you have any questions regarding this warranty or would like to obtain warranty service, please call 1-800-323-9519 and a convenient service center address will be provided to you.

In the U.S.A., this warranty is offered by Sunbeam Products, Inc. doing business as Jarlen Consumer Solutions located at 2381 Executive Center Drive, Boca Raton, Florida 33431. In Canada, this warranty is offered by Sunbeam Corporation (Canada) Limited, doing business as Jarlen Consumer Solutions, located at 20 B. Herford Street, Brampton, Ontario L6Y 0M1. If you have any other problem or claim in connection with this product, please call our Consumer Service Department. PLEASE DO NOT RETURN THIS PRODUCT TO ANY OF THESE ADDRESSES OR TO THE PLACE OF PURCHASE.

To register your product, please visit us online at www.crockpot.com.

© 2017 Sunbeam Products, Inc. doing business as Jarlen Consumer Solutions. All rights reserved. Distributed by Sunbeam Products, Inc. doing business as Jarlen Consumer Solutions, Boca Raton, Florida 33431. Sunbeam Products, Inc. is a subsidiary of Newell Brands Inc. (NYSE: NWL).

Printed in China

Express Crock Multi-Cooker_17EM2

193013 Rev B

CSH-SL0717-CRP52224

CROCKPOT®

• THE ORIGINAL SLOW COOKER •

Express Crock Multi-Cooker

Owner's Guide
Read and Keep These Instructions

www.crockpot.com

IMPORTANT SAFEGUARDS

When using electrical appliances, basic safety precautions should always be followed to reduce the risk of fire, electric shock, and/or injury to persons including the following:

1. Read all instructions before using this product.
2. This appliance cooks under pressure when using pressure cooking functions. Improper use may result in scalding injury. Make certain unit is properly closed before operating. See Operating Instructions.
3. This appliance generates heat during use. Do not touch hot surfaces. Use handles or knobs.
4. Do not fill the unit over maximum fill line at 2/3 full. When cooking foods that expand during cooking such as rice or dried vegetables, do not fill the unit beyond the recommended level at 1/2 full. Over filling may cause a risk of clogging the vent pipe and developing excess pressure. Follow all cooking and recipe instructions.
5. Always check the pressure release devices for clogging before use. Clean as necessary.
6. Place the Multi-Cooker so that the Steam Release Valve is positioned away from the body.
7. Never place any part of the body, including face, hands, and arms over the Steam Release Valve. Steam can result in serious burns.
8. Do not operate the Multi-Cooker without food or liquid in the Cooking Pot.
9. To prevent risk of injury due to excessive pressure,

replace Lid Sealing Gasket only as recommended by the manufacturer. See Care and Cleaning instructions.

10. Do not use the Lid to carry the Multi-Cooker.
11. Do not move or cover the Multi-Cooker while it is in operation.
12. After pressure cooking, do not open the pressure cooker until the unit has cooled and all internal pressure has been released. If the Lid is difficult to remove, this indicates that the cooker is still pressurized - do not force it open. Any pressure in the cooker can be hazardous. See Releasing Pressure Instructions.
13. Be careful when lifting and removing Lid after cooking. Always tilt the Lid away from you as steam is hot and can result in serious burns. Never place face over the Multi-Cooker.
14. Do not use this pressure cooker for pressure frying with oil.
15. To protect against electric shock, do not place or immerse cord, plugs, or appliance in water or other liquid.
16. Do not use the Cooking Pot for food storage or place in the freezer.
17. To prevent damage to the Multi-Cooker do not use alkaline cleaning agents when cleaning. Use a soft cloth and a mild detergent.
18. This appliance is **NOT** to be used by children or by persons with reduced physical, sensory, or mental capabilities.

19. Close supervision is necessary when any appliance is used near children. Children should not play with the appliance.
20. Always plug Power Cord fully into Multi-Cooker first, then plug cord into the wall outlet.
21. Unplug from outlet when not in use, before putting on or taking off parts and before cleaning. Allow to cool before putting on or taking off parts, and before cleaning. To disconnect, ensure that the Multi-Cooker is OFF, then unplug Power Cord from outlet. Do not disconnect by pulling on cord.
22. Do not operate any appliance with a damaged cord or plug or after the appliance malfunctions, or has been damaged in any manner. Do not attempt to replace or splice a damaged cord. Return appliance to the manufacturer (see warranty) for examination, repair or adjustment.
23. Do not let Power Cord hang over edge of table or counter or come into contact with hot surfaces.
24. Extreme caution must be used when moving an appliance containing hot liquids.
25. The use of accessory attachments not recommended by the appliance manufacturer may cause injuries.
26. Do not use outdoors or for commercial purposes.
27. Do not place on or near wet surfaces, or heat sources such as a hot gas or electric burner, or in a heated oven.

28. Do not use appliance for other than intended use. Misuse can cause injuries. This appliance is not intended for deep frying foods.
29. **CAUTION:** To protect against electrical shock and product damage, do not cook directly in the Heating Base. Cook only in the removable Cooking Pot provided.
30. **WARNING:** Spilled food can cause serious burns. Keep appliance and cord away from children. Never drape cord over edge of counter, never use outlet below counter, and never use with an extension cord.
31. Do not plug in or turn on the Multi-Cooker without having the Cooking Pot inside the Multi-Cooker.
32. Intended for household countertop use only. Keep 6 inches (152 mm) clear from the wall and on all sides. Always use appliance on a dry, stable, level surface.

SAVE THESE INSTRUCTIONS HOUSEHOLD USE ONLY

NORTH AMERICAN MODELS WITH POLARIZED PLUGS:

POLARIZED PLUG

This appliance has a polarized plug (one blade is wider than the other). To reduce the risk of electric shock, this plug is intended to fit into a polarized outlet only one way. If the plug does not fit fully into the outlet, reverse the plug. If it still does not fit, contact a qualified electrician. Do not attempt to modify the plug in any way. If the plug fits loosely into the AC outlet or if the AC outlet feels warm do not use that outlet.



POWER CORD INSTRUCTIONS:

A short Power Cord is used to reduce the risk resulting from it being grabbed by children, becoming entangled in, or tripping over a longer cord.

NOTICES:

1. Some countertop and table surfaces are not designed to withstand the prolonged heat generated by certain appliances. Do not set the heated Multi-Cooker on a finished wood table. We recommend placing a hot pad or trivet under your Multi-Cooker to prevent possible damage to the surface.
2. During initial use of this appliance, some slight smoke and/or odor may be detected. This is normal with many heating appliances and will not recur after a few uses.
3. Please use caution when placing your Cooking Pot on a ceramic or smooth glass cook top stove, countertop, table or other surface. It may scratch some surfaces if caution is not used. Always place heat resistant protective padding under the Cooking Pot before setting on a table, countertop or other surface.

CROCK-POT® EXPRESS CROCK MULTI-COOKER COMPONENTS

Figure 1

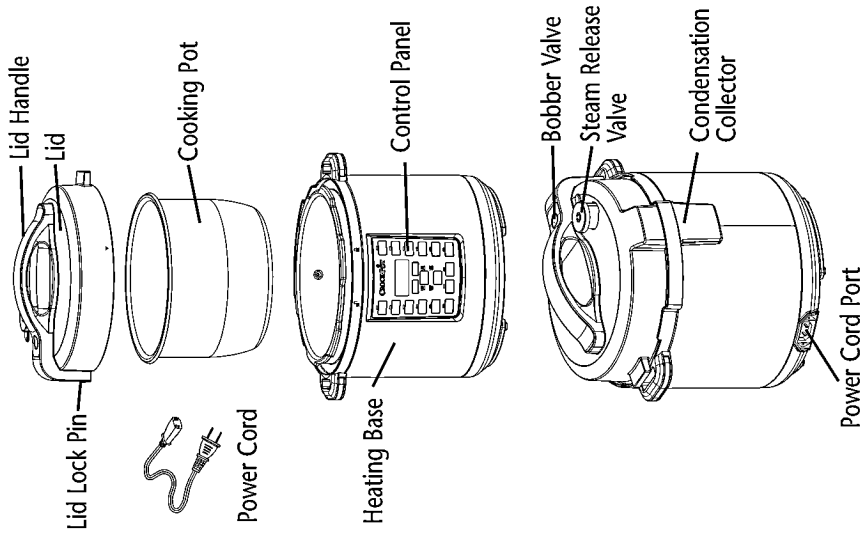

CROCK-POT® EXPRESS CROCK MULTI-COOKER COMPONENTS

CONTROL PANEL

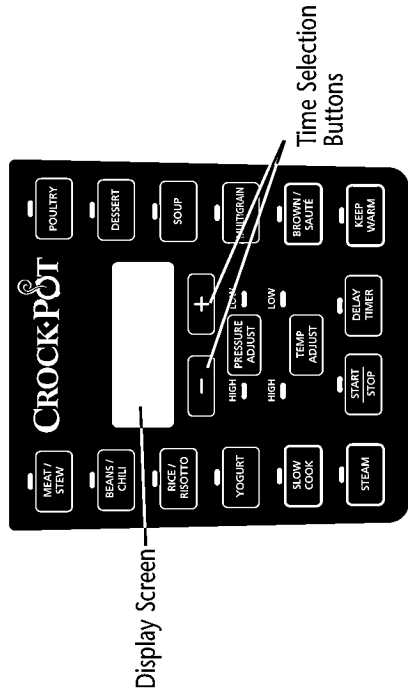

UNDERSIDE OF LID

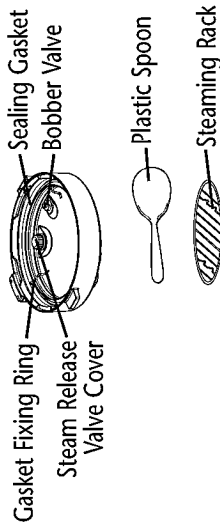

HOW TO USE YOUR EXPRESS CROCK MULTI-COOKER

Getting started:

Remove all packaging, paper, and cardboard (including any located between the Cooking Pot and Heating Base). Read and save the literature and be sure to read the service and warranty information.

Visit the Crock-Pot® website at www.crockpot.com for additional information, hints, tips and recipes or call 1-800-323-9519.

Assembly:

- Place Cooking Pot into the Heating Base
- Place Lid upon Multi-Cooker and align ▼ with ▲. To lock, twist counterclockwise, aligning ▼ with ▲. To unlock, twist Lid clockwise and align ▼ with ▲.

Open Lid

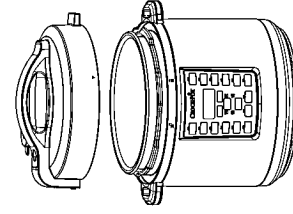

Unlocked Lid

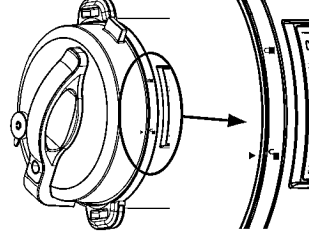

Locked Lid

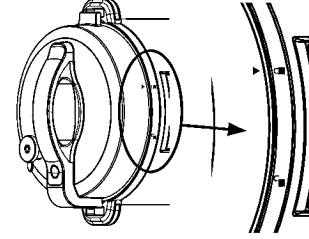

Figure 2

GETTING TO KNOW YOUR EXPRESS CROCK

1. Remove the Lid by turning clockwise to unlock, aligning ▼ with ■. Remove the Sealing Gasket from the Lid and wash the gasket and the Lid in warm soapy water. Dry the Sealing Gasket and Lid thoroughly before reattaching the Sealing Gasket to the Lid. Ensure the Sealing Gasket is smoothly and securely in place in the gasket holder. If the Sealing Gasket is not in the correct position the Lid will not be able to form a seal and will not be able to gain pressure.
2. Remove the Cooking Pot and the Condensation Collector and wash in warm, soapy water. Dry thoroughly before replacing back in the Multi-Cooker.

The Express Crock Multi-Cooker has been designed with safety in mind and has various safety measures.

1. Pressure will not build if the Lid is not shut correctly and has not sealed.
2. Ensure Lid is in the completely locked position and the ▼ is aligned with ■.
3. Pressure will not build if the Steam Release Valve has not been switched to the Seal "S" position.
4. Over filling may cause a risk of clogging the vent pipe and developing excess pressure.
5. The gasket and the valves can be removed for cleaning. (See page 32).
6. Once the pressure increases, the Lid cannot be opened. Safety sensors ensure the pressure remains within the set range.
6. The Steam Release Valve has an extended finger tab, designed to keep the hand away from the top of the valve. Always use a kitchen utensil when operating this tab. See **RELEASING PRESSURE** Instructions on page 18.
7. The pressure cooking functions require liquid to work. If the inside of the Cooking Pot does not have enough liquid, an error will appear in the Display Screen. See **ERROR CODES**

GETTING TO KNOW YOUR EXPRESS CROCK (CONT.)

chart on page 36.

8. At the end of cooking, the Lid cannot be unlocked until all the pressure is released. This can be done using the Natural Pressure Release Method or Quick Pressure Release Method, explained on page 18.
9. The Time Selection Buttons (+ and -) are used to set the cooking time. To advance slowly, simply press the + or - button and release. To advance quickly, press and hold the + or - button. If you have passed the desired time, simply press the opposite arrow button to return to the desired time.

NOTE: The timer can be selected for all programs and can be changed at any time during cooking by pressing **START/STOP** and selecting a new function.

10. The **PRESSURE ADJUST** button is used to select desired cooking pressure (HIGH or LOW). Each pre-set cooking setting automatically selects the optimum pressure for that selection, but it can be manually selected with this button (see the Cooking Guide on page 22 for available adjustments).
11. The **TEMP ADJUST** button is used to select desired temperature (HIGH or LOW). The temperature may only be adjusted on the **SLOW COOK**, **YOGURT**, and **BROWN/SAUTE** functions (see the Cooking Guide on page 22 for available adjustments).
12. The **START/STOP** button starts and stops a cooking function. It must be pressed to change from one cooking function to another after cooking has begun.
13. The Display Screen shows how much longer the food needs to cook from the selected time in hours and minutes once the Multi-Cooker is preheated. While the Multi-Cooker is preheating, the display screen will show, "HEAT".

GETTING STARTED

(NOTE: The Multi-Cooker beeps as each button is pressed.)

1. Add desired ingredients to Cooking Pot. Place Lid on top of Multi-Cooker and align ▼ with ◻. To lock, twist counterclockwise, aligning ▼ with ◻.
2. Plug provided Power Cord into the Power Cord Port of the Multi-Cooker.
3. Plug other end of the Power Cord into a wall power outlet.
4. Select the cooking function you would like to use.
5. The **START/STOP** button and the time on the screen will flash.
6. Select the desired cook time by using the + and - buttons. Select the desired temperature using the **TEMP ADJUST** button (if applicable). Select the desired pressure using the **PRESSURE ADJUST** button. (Please refer to the Cooking Guide chart on page 22 for time and temperature recommendations.)
7. Press the **START/STOP** button. For pressure cooking functions, the word "HEAT" will appear on the Display Screen during preheating time. Once the Multi-Cooker is preheated, the selected cooking time will appear on Display Screen.
Note: For pressure cooking functions, 13-14 minutes is the approximate average preheat time. If food content is larger or very cold, preheat time may take slightly longer.
8. This Multi-Cooker allows you to delay the start of your cooking so that cooking finishes when you need it. See page 13 for instructions on the **DELAY TIMER** function.
9. After the set cooking time has elapsed, the Multi-Cooker will beep again and will automatically switch to the **KEEP WARM** setting. The Display Screen will then change from the cook time to a new timer that

GETTING STARTED (CONT.)

will count up to 4:00 (4 hours) or until you press the **START/STOP** button. After 4 hours in the **KEEP WARM** setting, the Multi-Cooker will turn off.

10. To end a cooking function at any time, press the **START/STOP** button.
11. When finished, unplug the Multi-Cooker and wait for it to cool completely before attempting to clean.
CAUTION: The Cooking Pot and Heating Base will get very hot while using this Multi-Cooker. Do not touch hot surfaces. Always use pot holders or oven-mitts when using this Multi-Cooker. Always lift the Lid by tilting away from you to avoid the steam.

HOW TO USE THE TIME DELAY

This Multi-Cooker allows you to delay the start of your cooking so that cooking finishes when you need it.

Note: The **DELAY TIMER** function is not available on the **BROWN/SAUTE, KEEP WARM, or YOGURT** settings.

Note: Do not use the **DELAY TIMER** function when the recipe has perishable ingredients such as meat, fish, eggs, or dairy, as these may spoil.

1. Adjust the Multi-Cooker settings using the instructions on pages 16-29.
2. After setting the cooking time, press the **DELAY TIMER** button. The **DELAY TIMER** and **START/STOP** buttons will flash, and "0:30" will flash on the Display Screen, to indicate the Multi-Cooker is being programmed on the delay setting.
3. Press the + and - buttons until you reach the number of hours and minutes you want the cooking process to be delayed (i.e., set the amount of time you wish to delay the cooking cycle).

HOW TO USE THE TIME DELAY (CONT.)

4. Press **START/STOP** button to begin the delay feature. The timer and **DELAY TIMER** button will stop flashing, while the **START/STOP** button will continue flashing. This will indicate that the Multi-Cooker has been set on the **DELAY TIMER** setting. The Display Screen will countdown the delay time until 0:00 is reached. When 0:00 is reached, the **DELAY TIMER** light will turn off and the **START/STOP** light will stop flashing to show that time delay has finished. The word "HEAT" will appear on the display screen until the Multi-Cooker is fully pressurized. When the selected pressure has been reached, the timer will start counting down.

Example:

It's 4pm and you want to have a soup cooked and ready in 2 hours' time for dinner at 6pm. You want to set the machine now so you are free to do other things.

The pre-set function (if unchanged) will cook for 30 minutes at HIGH pressure. Time to gain pressure varies according to humidity and water temperature, but let's assume it takes 15 minutes to gain pressure. Therefore total time is 45 minutes. To have the stew ready by 6pm, you will need to delay the start of your cooking by approximately 1 hour and 15 minutes.

1. Press **SOUP**
2. The Display Screen will flash "0:30"
3. Press the **DELAY TIMER** button and set for "1:15"
4. Press **START/STOP**

COOKING POT MARKINGS

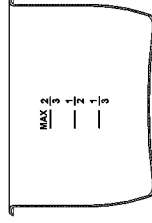

Figure 3

Inside the removable Cooking Pot are markings to guide the fill level of the Cooking Pot. The word MAX indicates the maximum fill line. The 1/3, 1/2, and 2/3 markings are handy guides to use in your recipes.

CAUTION: Never load the Cooking Pot above the maximum ingredient level line marked MAX on the inside of the Cooking Pot.

Foods that expand during cooking (e.g. rice) should never go above the 1/2 mark.

Note: The Multi-Cooker cannot pressure cook without liquid. Ensure a minimum of 8oz of liquid is used inside the removable Cooking Pot.

PRESSURE COOKING

Pressure cooking is an ideal way to create quick, flavorful meals. Pressure cooking is a method of cooking food in liquid (water, stock, wine, etc.) in a sealed Cooking Pot. The sealed Multi-Cooker retains steam and builds pressure, raising the temperature of the liquid inside the pot above boiling point. The increased temperature of the liquid and the steam results in reduced cooking times.

HIGH Pressure Setting is 6.5 - 10 PSI (45 - 70 kPa). It is suitable for a wide range of foods.

LOW Pressure Setting is 3.3 - 6.5 PSI (23 - 45 kPa). It is more suited to delicate foods like chicken fillet, fish and some vegetables.

KEEP WARM Setting: When cooking time is completed, the Multi-Cooker automatically switches to the **KEEP WARM** setting to prevent overcooking and to keep your cooked food warm until serving - perfect for busy families, those on the run and those who need flexible meal times. This setting is not hot enough to cook and should only be used to keep warm, cooked food for serving.



Ideal Meals to Pressure Cook: Soups, stocks, casseroles, sauces (e.g. pasta sauces), meat, rice, firm vegetables (beetroot, potatoes) and desserts (e.g., pudding).

Capacity: Never fill the Cooking Pot above the MAX line. Foods that expand during cooking should never go above the 1/2 mark. The Multi-Cooker cannot pressure cook without liquid. Ensure a minimum of 8oz of liquid is used inside the removable Cooking Pot.

USING THE PRESSURE COOKING FUNCTIONS

Place the Multi-Cooker on a flat, level surface.

Place Cooking Pot inside Heating Base. Plug the Multi-Cooker into a wall outlet. The Multi-Cooker will beep, and the Display Screen will illuminate with four dashes (----).

1. Place your food and liquid inside the removable Cooking Pot.
2. Place the Lid onto the Multi-Cooker and align  with . To lock, rotate counterclockwise to the **LOCKED**  position.
3. Using the finger tab, rotate the Steam Release Valve to the "Seal" position.
4. Select the desired cooking function
5. Adjust the cooking time and pressure if necessary.

Note: See the Cooking Guide on page 22 to find the possible time and pressure adjustments

6. Once you have made the desired adjustments, if any, press **START/STOP**.
7. The Multi-Cooker needs to gain pressure before pressure cooking can begin. When the Multi-Cooker is gaining pressure, "HEAT" will appear on the Display Screen and the time will not count down. The amount of time the Multi-Cooker takes to gain pressure varies according to humidity

and water temperature, but average pressurization time is 13-15 minutes. When pressure has been reached, "HEAT" will disappear on the Display Screen, and the time will begin to count down.

8. After the set cooking time has elapsed, the Multi-Cooker will beep and will automatically switch to the **KEEP WARM** setting. The Display Screen will therefore change from the cook time to a new timer that will count up to 4:00 (4 hours) or until you press the **START/STOP** button. After 4 hours in the **KEEP WARM** setting, the Multi-Cooker will go into stand-by mode, and the Display Screen will illuminate with four dashes (----).

USING THE PRESSURE COOKER FUNCTIONS (CONT.)

TIP:

1. The pressure cooking settings are in the Cooking Guide table on page 22.
2. If the lid is not shut correctly or if the Steam Release Valve is not in the "Seal/" position, the Multi-Cooker cannot gain pressure and an ERROR message will appear in the Display Screen. Ensure that the Sealing Gasket is placed evenly in the lid. See the ERROR CODES chart on page 36.
3. It is common for some steam to release through the Bobber Valve during the cooking cycle. This is part of normal operation of the unit.

Note: The Multi-Cooker cannot pressure cook without liquid. Ensure a minimum of 8oz of liquid is used inside the removable Cooking Pot.

CAUTION: During cooking, steam will build up in the Multi-Cooker, so when lifting the Lid use a kitchen glove or mitt to protect your hand.

RELEASING PRESSURE AT THE END OF COOKING

- A. **Natural Pressure Release Method:** After cooking cycle is complete, let Multi-Cooker naturally release pressure through the Bobber Valve. Unit will gradually cool down on its own. Wait at least 10 minutes after cooking has completed, and then, using a kitchen utensil, flick the tab on the Steam Release Valve to the "Release" position (see Figure 4). Do not place any part of your hand or body over the steam outlet on top of the valve, as steam is very hot and can scald skin. The pressure has been released when steam is no longer escaping from the valve and the Lid opens freely with minimal force. Only then is it safe to remove the Lid and serve food.

RELEASING PRESSURE AT THE END OF COOKING (CONT.)

- B. **Quick Pressure Release Method:** Using a kitchen utensil, flick the tab on the Steam Release Valve to the "Release" setting (see Figure 4). Steam will release rapidly from the Steam Release Valve. Do not place any part of your hand or body over the steam outlet on the top of the valve, as steam is very hot and can scald skin. **Never use this method when cooking liquid ingredients such as casseroles, stocks and soups. Never use this method when cooking rice, as rice tends to be very delicate.** The pressure has been released when steam is no longer escaping from the valve and the Lid opens freely with minimal force. Only then is it safe to remove the Lid and serve food.

CAUTION:

1. Do not force the Lid to open. If it does not open easily this means that the Multi-Cooker is still under pressure.
2. During cooking, steam will build up in the Multi-Cooker, so when lifting the Lid use a kitchen glove or mitt to protect your hand.

Pressure Release Valve
Valve CLOSED ("Seal/")

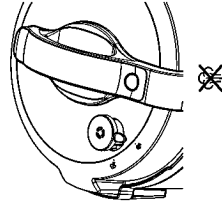

Valve OPEN ("Release/")

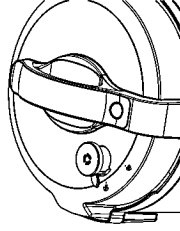

Valve REMOVE

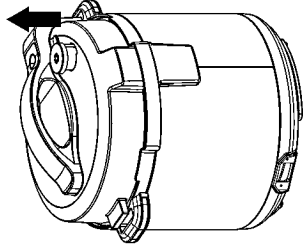

Figure 4

SLOW COOKING

LOW Setting: This is suitable for simmering and slow cooking. Recommended cooking times in LOW are from 6 to 8 hours.

HIGH Setting: This is for faster cooking. Recommended cooking times in HIGH are from 2 to 4 hours.

KEEP WARM Setting: When cooking time is completed, the Multi-Cooker automatically switches to the **KEEP WARM** setting to prevent overcooking and to keep your cooked food warm until serving - perfect for busy families, those on the run and those who need flexible meal times. This setting is not hot enough to cook and should only be used to keep hot, cooked food warm for serving.

Note: When slow cooking, the ideal fill level for your ingredients is between the 1/2 and 2/3 marks. Never fill the Cooking Pot above the MAX line.

USING THE SLOW COOK FUNCTION

The **SLOW COOK** function does not use pressure in the cooking process, but some pressure can build inside the unit during cooking. When using this function, ensure the Steam Release Valve is in the "Release" position. This function will cook similarly to standard slow cookers, using lower temperatures and longer cooking times to achieve tender, flavorful meals. Place the Multi-Cooker on a flat, level surface.

Place Cooking Pot inside Heating Base. Plug the Multi-Cooker into a wall outlet. The Multi-Cooker will beep, and the Display Screen will illuminate with four dashes (- - - -).

1. Place your food and liquid inside the removable Cooking Pot.
2. Place the Lid onto the Multi-Cooker and align ▼ with ■. To lock, rotate counterclockwise to the **LOCKED** □ position.

USING THE SLOW COOK FUNCTION (CONT.)

3. Using the finger tab, rotate the Steam Release Valve to the "Release" position.

Note: Although this setting will not use pressure in the cooking process, some pressure can build inside the unit during cooking. This is why it's important to keep the Steam Release Valve in the "Release" position.

4. Press the **SLOW COOK** button and adjust the time and temperature as needed.

Note: See the Cooking Guide on page 22 to find the possible time and temperature adjustments.

5. Press **START/STOP**. The time will begin to count down.
6. After the set cooking time has elapsed, the Multi-Cooker will beep and will automatically switch to the **KEEP WARM** setting. The Display Screen will therefore change from the cook time to a new timer that will count up to 4:00 (4 hours) or until you press the **START/STOP** button. After 4 hours in the **KEEP WARM** setting, the Multi-Cooker will turn off.

Note: As the **SLOW COOK** function does not cook under pressure, you can remove the lid during cooking to check your slow cooking progress. Only lift the Lid if necessary. Since slow cooking uses lower temperatures to cook, the Multi-Cooker will not recover lost heat very quickly, which may impact cooking times.

TIP: The **SLOW COOK** settings are in the Cooking Guide on page 22.

CAUTION: During slow cooking, steam may build up in the Multi-Cooker, so when lifting the Lid use a kitchen glove or mitt to protect your hand.

COOKING GUIDE

Cooking Function	Default Setting	Pressure Adjustments	Temperature Adjustments	Cook Time Range
SLOW COOK	High temp / 4 hours	N/A	Low-High	30 minutes – 20 hours
STEAM	High pressure / 10 minutes	Low-High	N/A	3 minutes – 1 hour
BROWN/ SAUTÉ	High temp / 30 minutes	N/A	Low-High	5 minutes – 30 minutes
KEEP WARM	Warm temp / 4 hours	N/A	Warm	30 minutes – 4 hours
MEAT/STEW	High pressure / 35 minutes	Low-High	N/A	15 minutes – 2 hours
BEANS/CHILI	High pressure / 20 minutes	Low-High	N/A	5 minutes – 2 hours
RICE/ RISOTTO	Low pressure / 12 minutes	Low-High	N/A	6 minutes – 30 minutes
YOGURT	Low temp / 8 hours	N/A	Low-High	Low: 6 hours - 12 hours High: N/A
POULTRY	High pressure / 15 minutes	Low-High	N/A	15 minutes – 2 hours
DESSERT	Low pressure / 10 minutes	Low-High	N/A	5 minutes – 2 hours
SOUP	High pressure / 30 minutes	Low-High	N/A	5 minutes – 2 hours
MULTIGRAIN	High pressure / 40 minutes	Low-High	N/A	10 minutes – 2 hours

STEAMING

The **STEAM** function is perfect for gently steaming fish and vegetables. It is pre-programmed to use the HIGH pressure cooking setting. When steaming, use the Steaming Rack.. **Capacity:** When the Multi-Cooker is used with the **STEAM** function, the maximum capacity of liquid should be just under the rack wires, so that the liquid is not touching the food.

Note: The unit cannot pressure cook without liquid. Ensure a minimum of 8oz of liquid is used inside the removable Cooking Pot.

USING THE STEAM FUNCTION

Place the Multi-Cooker on a flat, level surface.

Place Cooking Pot inside Heating Base. Plug the Multi-Cooker into a wall outlet. The Multi-Cooker will beep, and the Display Screen will illuminate with four dashes (----).

1. Add 8oz of water to the bottom of the removable Cooking Pot and insert the cooking rack. Ensure water is just under the wires of the rack so that food is not touching water.
2. Place your food on the cooking rack.
3. Place the Lid on and lock by rotating counterclockwise to the **LOCKED** position.
4. Using the finger tab, flick the Steam Release Valve to the "Seal" position.

USING THE STEAM FUNCTION (CONT.)

- Press the **STEAM** button and adjust the time and pressure as needed.
Note: See the Cooking Guide on page 22 to find the possible time and pressure adjustments.
- Once you have made the desired adjustments, if any, press **START/STOP**.
- The Multi-Cooker needs to gain pressure before pressure cooking can begin. When the Multi-Cooker is gaining pressure, "HEAT" will appear on the Display Screen and the time will not count down. When pressure has been reached, "HEAT" will disappear on the Display Screen, and the time will begin to count down.
- After the set cooking time has elapsed, the Multi-Cooker will beep and will automatically switch to the **KEEP WARM** setting. The Display Screen will therefore change from the cook time to a new timer that will count up to 4:00 (4 hours) or until you press the **START/STOP** button. After 4 hours in the **KEEP WARM** setting, the Multi-Cooker will turn off.

TIP: See the Steaming Chart on page 25.

CAUTION: During cooking, steam will build up in the Multi-Cooker, so when lifting the Lid use a kitchen glove or mitt to protect your hand.

STEAMING CHART

Food	Amount	Amount of water	Pre-prep	Cooking Time
Vegetables				
Asparagus	1 lb	2 cups	Whole/trimmed	4 - 5 minutes
Broccoli	1 bunch	2 cups	2-inch florets	2 - 3 minutes
Baby carrots or 1 ½-inch pieces	1 lb	2 cups	Peeled and trimmed	2 - 3 minutes
Cauliflower	1 medium head	2 cups	2-inch pieces	2 - 3 minutes
Corn on the cob	4	2 cups	6-inches	3 - 5 minutes
Green beans	1 lb	2 cups	Whole/trimmed	2 - 3 minutes
Snow peas	1 lb	2 cups	Whole/trimmed	1 - 3 minutes
Small new Potatoes	1 lb	2 cups	Whole	x minutes
White or Yukon Gold potatoes	12 ounces	2 cups	Quartered	7 - 9 minutes
Sweet Potatoes	12 ounces	2 cups	Cut in 1 ½-inch pieces	7 - 9 minutes
Yellow squash or zucchini	1 lb	2 cups	Thickly sliced	6 - 8 minutes
Poultry				
Eggs	8	2 cups	Whole in shell	6 - 9 minutes
Fish				
Lobster tails	Large	2 cups	In shell	3 - 4 minutes
Large Shrimp	1 lb	2 cups	Peeled and deveined	1 - 3 minutes
Salmon	1 lb	2 cups	Cut in serving size pieces	3 - 5 minutes

USING THE BROWN/SAUTÉ FUNCTION

This setting does not cook under pressure. It works similarly to standard cooking, requiring dry heat, and therefore does not need the Lid. Do not use the Lid with this function.

Place the Multi-Cooker on a flat, level surface. Place Cooking Pot inside Heating Base. Plug the Multi-Cooker into a wall outlet. The Multi-Cooker will beep, and the Display Screen will illuminate with four dashes (----).

1. Select the **BROWN/SAUTÉ** function and adjust the time and temperature if necessary, using the + and - buttons.
2. Press **START/STOP**.
3. When the Multi-Cooker is pre-heating, "HEAT" will appear on the Display Screen. When the temperature has been reached, the timer will start counting down. Using plastic tongs, carefully add your food to the hot pot.

BROWN/SAUTÉ can be used for each of the following:

- A. Brown (sear) meats for casseroles and soups. Browning meat prior to pressure cooking and slow cooking not only gives your food great color, but it also seals in the juices and flavors and keeps the meat tender.
- B. Sauté onions or mirepoix (mixture of chopped onion, carrot, and celery), among many other foods, often used in pressure cooker and slow cooker recipes. Sautéing onions allows caramelization which contributes to flavor and color in the end dish.

Capacity: When the Multi-Cooker is used to brown or sauté it may be best to cook in batches to ensure the food is evenly cooked.

RICE COOKING

When cooking rice, use the **RICE/RISOTTO** function. This is suitable for all types of rice, including white and/or brown rice.

The **RICE/RISOTTO** function cooks under pressure for faster cooking.

Capacity: Since rice expands during cooking, do not fill Cooking Pot above the 1/2 mark when using the **RICE/RISOTTO** function.

USING THE RICE/RISOTTO FUNCTION

Place the Multi-Cooker on a flat, level surface.

Place Cooking Pot inside Heating Base. Plug the Multi-Cooker into a wall outlet. The Multi-Cooker will beep, and the Display Screen will illuminate with four dashes (----).

1. Measure the desired quantity of rice.

Note: 1 cup uncooked white rice = 2 cups of cooked white rice (approximately). 1 cup uncooked brown rice = 2 cups cooked brown rice (approximately).

2. Place the measured rice in a strainer and wash rice thoroughly under cold water. Wash until the water runs clear. This removes excess starch which helps to achieve fluffier rice, and prevents rice grains sticking to the Cooking Pot. Rinsing the rice reduces the build-up of starchy water and bubbles that sometimes form around the Valve Cover and Lid, which can cause spitting from the Steam Release Valve.
3. Ensure the Cooking Pot is clean and dry before placing it inside the Heating Base.
4. Place the washed rice in the Cooking Pot. Add the quantity of water needed for your recipe (Standard ratio -- 1 cup of uncooked rice : 1.5 cups of water). Ensure that a minimum of 8oz of liquid is placed inside the removable Cooking Pot.

USING THE RICE/RISOTTO FUNCTION (CONT.)

5. Place the Lid on and lock by rotating counterclockwise to the **LOCKED** position.
6. Using the finger tab, flick the Steam Release Valve to the "Seal" position.
7. Press the **RICE/RISOTTO** button and adjust the time and pressure as needed.

Note: See the Cooking Guide on page 22 to find the possible time and pressure adjustments.

8. Once you have made the desired adjustments, if any, press **START/STOP**.
9. The Multi-Cooker needs to gain pressure before pressure cooking can begin. When the Multi-Cooker is gaining pressure, "HEAT" will appear on the Display Screen and the time will not count down. When pressure has been reached, "HEAT" will disappear on the Display Screen, and the time will begin to count down.
10. After the set cooking time as elapsed, the Multi-Cooker will beep and will automatically switch to the **KEEP WARM** setting. The Display Screen will therefore change from the cook time to a new timer that will count up to 4:00 (4 hours) or until you press the **START/STOP** button. After 4 hours in the **KEEP WARM** setting, the Multi-Cooker will turn off.

TIPS:

1. Do not keep rice in the pot for extended periods of time on the **KEEP WARM** setting, as the rice will become dry and the quality will deteriorate. Use the supplied plastic spoon to stir and serve the rice. Do not use metal utensils, as these will scratch the non-stick coating.
2. As rice grains can be delicate, at the end of cooking wait until the pressure releases naturally. Do not use the Quick Pressure Release Method (see page 18 for instructions on the Natural Pressure Release Method).

USING THE RICE/RISOTTO FUNCTION (CONT.)

3. Standard ratio for cooking rice -- 1 cup of uncooked rice : 1.5 cups of water

CAUTION: During cooking, steam will build up in the Multi-Cooker, so when lifting the Lid use a kitchen glove or mitt to protect your hand.

TO CHANGE A SETTING

It's easy to switch functions during cooking. Press the **START/STOP** button and then select the new desired cooking function. A new timer will flash on the Display Screen, and the selected function will also flash. Select the desired time, pressure, and/or temperature. Press the **START/STOP** button and the new function will begin preheating.

To Change the Cooking Time:

You can change the cooking time before cooking begins by pressing the + and - buttons before pressing **START/STOP**. Press and release to change slowly. Press and hold to change time quickly. If you pass the desired temperature or time, press the opposite button.

To Change the Pressure:

You can change the pressure on certain pre-set functions before cooking begins by pressing the **PRESSURE ADJUST** button before pressing **START/STOP**.

To Change the Temperature:

You can change the temperature on certain functions before cooking begins by pressing the **TEMP ADJUST** button before pressing **START/STOP**.

CARE AND CLEANING

Cleaning should only be carried out when the the Express Crock is cool and unplugged. Allow the Multi-Cooker to completely cool before cleaning. Do not use the removable Cooking Pot on the stovetop, inside a microwave oven or inside an oven. Use the pot only inside the Express Crock Heating Base. Wash the Sealing Gasket and Lid by hand in warm, soapy water. Dry all parts thoroughly.

Cooking Pot:

When removing the Cooking Pot from the Heating Base, always use two hands and lift directly upward. Failure to do so may result in scratching the outside of the Cooking Pot (see figure 5).

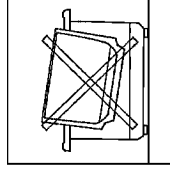
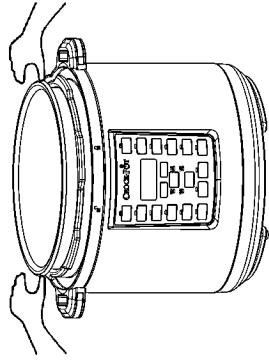

Figure 5

CARE AND CLEANING (CONT.)

If food sticks or burns to the surface of the Cooking Pot, then fill it with hot soapy water and let it soak before cleaning.

Use a rubber or nylon spatula to remove stubborn residue. If scouring is necessary, use a non-abrasive cleaner and a nylon scouring pad or brush.

Although the Cooking Pot is dishwasher safe, we recommend hand-washing to preserve the non-stick coating.

If white spots form on surface of Cooking Pot, then soak it in a solution of vinegar or lemon juice and warm water for 30 minutes. Rinse and dry.

Note: Never use metal utensils or cleaning devices on the Cooking Pot, as this may result in scratching and damaging the non-stick coating.

Exterior

Wipe the exterior of the Heating Base with a damp cloth and polish dry. **DO NOT** use harsh abrasives, scourers or chemicals, as these will damage the surfaces. To prevent damage to the Multi-Cooker do not use alkaline cleaning agents when cleaning. Only use a soft cloth and mild detergent. Never immerse the heating base in water or any other liquid.

Condensation Collector

Empty any collected water from the Condensation Collector after each use. Wash in warm, soapy water.

Lid and Sealing Gasket

Always examine the gasket before each use. The silicon Sealing Gasket on the inside of your Multi-Cooker Lid may deteriorate over time. Remove Sealing Gasket for cleaning as needed. Hand clean using warm, soapy water, dry thoroughly, and replace Sealing Gasket in Lid before use. Leave the Lid upturned for storage, as this will also extend the life of the gasket. Sealing Gasket may need to be replaced every 1 – 2 years depending on regular use. Contact Crock-Pot® customer service to order replacement parts.

Steam Release Valve

Ensure the Steam Release Valve is clear from debris before you begin using the Multi-Cooker. Remove the valve and gently clean. Ensure it is completely dry before replacing.

Steam Release Valve Cover

The Steam Release Valve Cover is on the underside of the Lid. Ensure it is clear from debris before you begin using the Multi-Cooker. To clean, carefully pull the cover off and clean using warm, soapy water. Press the cover back into its place after cleaning is complete.

UNDERSIDE OF LID

Figure 6

Bobber Valve

Gently press the valve up and down 2-3 times and ensure it is clear from debris before you begin using the Multi-Cooker.

Lid Lock Pin

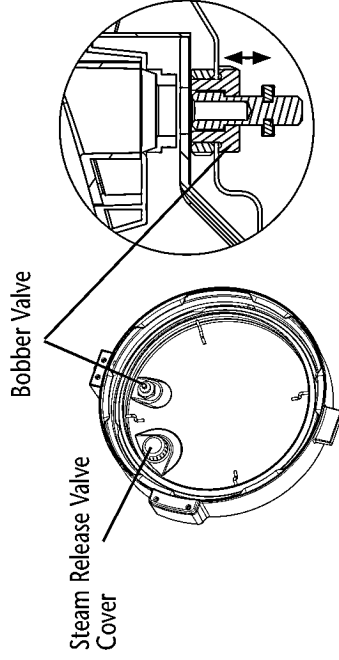
Gently press the pin and ensure it is clear from debris before you begin using the Multi-Cooker.

Note:

1. Condensation may collect inside the Heating Base under the removable Cooking Pot. This is normal. Allow to cool, and then dry using kitchen cloth.
2. Always make sure that each component (pot, valves, gasket, etc.) is completely dry before you put back into the Multi-Cooker.

TROUBLESHOOTING

Subject	Question	Solution
Power	My Multi-Cooker will not turn on	Make sure outlet is functioning properly
		Check that the Multi-Cooker is plugged in
		Call Customer Service at 1-800-323-9519
Doneness of food	My food was undercooked	Make sure you selected the proper cooking setting
		Make sure the Lid is properly placed and locked, and that Steam Release Valve in "Seal" (closed) position.
		Check the recipe to see that the proper pressure, temperature, and time selection were made
		Be sure the power was not interrupted
		Make sure the Cooking Pot has enough liquid to create desired steam and build pressure. Minimum of 8oz of liquid should be used when pressure cooking. Never fill over the "MAX" line.
	My food was overcooked	Make sure the Cooking Pot was at least ½ full
		Check that the proper pressure, temperature, and time were selected
Programming	Can I set a time for the Brown/Sauté program?	Because sautéing is a function that generally requires your full attention this may not be necessary. However, if desired a time can be selected.

TROUBLESHOOTING (CONT.)

Subject	Question	Solution
	Can I change the cooking function, time or temperature once the food is cooking?	Yes, to change the cooking function, press START/STOP and select a new cooking function. Change the time and temperature as required for the food. Press START/STOP again. The time and temperature can be changed at any time.
Cooking	Can the Cooking Pot and Lid be used on top of the stove or in the oven?	The Cooking Pot and Lid are not oven safe. Neither can be used on the stove or in the oven.
	I stopped the cooking process and changed pressure settings, and now the Multi-Cooker is preheating again.	If a cooking cycle is stopped and a new one is started, the Multi-Cooker may display "HEAT" until the new pressure is achieved.
Steam	Steam is leaking out of the Multi-Cooker	<ul style="list-style-type: none"> It is normal for a small amount of steam to come out of the Bobber Valve before the Multi-Cooker is pressurized. If steam is coming out from the perimeter of the Lid, the Lid has not been closed and locked completely.
Lid	I am having trouble removing the Lid.	There is a safety feature to keep Lid from being removed while the Multi-Cooker is under pressure. Please make sure to depressurize the unit by rotating the Steam Release Valve into the "Release" (Open) position. Refer to Releasing Pressure section for further instructions.

ERROR CODES

Error	Solution
"CLOSE LID" blinking light	Ensure that the Lid is closed completely and in the LOCKED position, aligning ▼ with ▲.
Display "E1"	The Multi-Cooker will stop the cooking cycle. Unplug Multi-Cooker and contact service center.
Display "E2"	The Multi-Cooker will stop the cooking cycle. Unplug Multi-Cooker and contact service center.
Display "E3"	The Multi-Cooker will stop the cooking cycle. Unplug Multi-Cooker, and allow to cool down completely. Once Multi-Cooker has cooled down, check all parts of the Lid (See pages 32-33). Turn Lid to LOCKED position. Ensure Steam Release Valve is in "Seal" (closed) position. If this error code occurs again, unplug Multi-Cooker and contact service center.
Display "E4"	The Multi-Cooker will stop the cooking cycle. Unplug Multi-Cooker, and allow to cool down completely. Once Multi-Cooker has cooled down, check Cooking Pot to ensure there is enough liquid inside. Add more liquid if necessary (Minimum 8oz). Ensure no steam is coming out of Cooking Pot before placing Lid back on Multi-Cooker. Turn Lid to LOCKED position. Ensure Steam Release Valve is in "Seal" (closed) position. Select a pressure cooking function, and then press START/STOP .
Display "E5"	The Multi-Cooker will stop the cooking cycle. Unplug Multi-Cooker and allow to cool. Once it is cooled down, remove the Lid and check the Cooking Pot. Do not use the Lid when using the BROWN/SAUTE function. When using the SLOW COOK function, make sure that the Steam Release Valve is in the "Release" (open) position before starting the cooking cycle.
Display "E6"	The Multi-Cooker will stop the cooking cycle. Unplug Multi-Cooker and allow to cool. Once it is cooled down, remove the Lid and check the Cooking Pot. Add liquid as necessary. Ensure a minimum of 8oz of liquid is used inside the removable Cooking Pot. If using a pressure cooking function, ensure that the Steam Release Valve is in the "Seal" (closed) position.

HINTS AND TIPS

Hints and Tips to get the best use of your Crock-Pot® Express Crock Multi-Cooker: Go to the Crock-Pot® website at www.crockpot.com for additional recipes, hints, tips and much more.

With your Express Crock you can create a large variety of delicious meals, snacks and desserts. Various foods take different times to cook perfectly, so sometimes it may take some trial and error to get the cooking times right for you.

1. Please refer to your Crock-Pot® Express Crock owner's manual when using your Multi-Cooker.
2. Never fill the Cooking Pot past the MAX line.
3. Do not leave Multi-Cooker plugged in when not in use.
4. Make sure Multi-Cooker is kept away from cabinets and walls when in use.
5. The Cooking Pot is designed to be used only in this Multi-Cooker. Do not use on stovetop, in microwave, or in oven.
6. The provided Steaming Rack is designed to be used in this Multi-Cooker. It should not damage the surface of the Cooking Pot.
7. When removing the Lid, use a pot holder to grasp the Lid Handle and lift away from your body to allow steam to escape.
8. Always place a trivet or pot holder under the Cooking Pot if it is removed from the Heating Base.

HINTS AND TIPS FOR SLOW COOKING

- If you are slow cooking, you can use the **BROWN/SAUTÉ** function first, which allows you to sear meats and vegetables at the beginning but also allows you to thicken sauces and make gravies at the end. Browning meat prior to slow cooking not only gives your food great color, but it also seals in the juices and flavors and keeps the meat tender.
- To thicken a casserole at the end of cooking, use the **BROWN/SAUTÉ** function and stir a small amount of corn flour with water. Allow to simmer, stirring until thickened.
- When using the **SLOW COOK** function, make sure the Steam Release Valve is in the "Release" (open) position.
- When using the **SLOW COOK** function, the Multi-Cooker does not recover lost heat quickly, so only lift the Lid if necessary or if instructed to do so in the recipe. It's a good idea to monitor your slow cooking results throughout the cooking cycle by quickly removing the Lid and checking, then quickly replacing the Lid. Different cuts and thickness of meats and vegetables can vary cooking times.

HINTS AND TIPS FOR SLOW COOKING (CONT.)

- It is not uncommon for meat to cook faster than root vegetables. It is for this reason that we recommend chopping all vegetables to a similar small size. Meat can be cut into larger chunks because if it is cut too small, it will break up once cooked and tenderized.
- Slow Cooking reduces evaporation, resulting in the flavors and juices being maintained. Keep this in mind when creating your own recipes, as you may not require as much liquid as you would when using other cooking methods.

Temperature	Temperature Suggestions	Recipes Ideas
High	Use this setting for recipes that require shorter cooking times, generally 4-6 hours.	Ideal for sauces, chili, potato dishes, cheese dishes, chicken wings and meatballs in sauce
Low	Use this setting for recipes that require longer cook times. This setting is used for recipes that usually require cooking for more than 8 hours. Perfect for less tender cuts of meats.	Ideal for less tender cuts of meat, braised meats, dried beans, soups and stews